

Product availability: Non-Stock - Not normally stocked in distribution facility

Price*: 167.28 USD



Main

Range of Product	Modicon M171/M172
Product or Component Type	Controller
Product Specific Application	HVAC and pumping solution
Variant	Programmable
Number of inputs/outputs	22
Discrete input number	6
Discrete output number	1 open collector 3 relay outputs SPST with same common 2 relay outputs SPST with independent common
Discrete output current	2 A relay
Analogue input number	2 configurable 3 analog input NTC
Analogue output number	3 voltage 0...10 V 2 PWM/PPM 20 kHz, 12 V, 35 mA

Complementary

Number of port	1 LAN expansion bus 1 RS485 - screw terminal block Modbus serial link
Input/output number	5 analog output 6 digital input 5 analog input 6 digital output
Discrete input logic	Sink or source (positive/negative)
Contacts usage	Volt-free contacts
Analogue input type	Voltage 0...5 V ratiometric) Voltage 0...10 V Current 0...20 mA/4...20 mA Voltage 0...1 V temperature probe - 50...100 °C 0.1 °C
Sensor power supply	12 V DC 85 mA 5 V DC 20 mA
[Us] rated supply voltage	24 V 12...24 V AC
Realtime clock	Built-in -4...131 °F (-20...55 °C)

Display type	Four 7-segment display units
Overvoltage category	II
Local signalling	6 LEDs (red) 5 LEDs (green) for programmable 7 LEDs (amber)
Mounting Support	DIN rail
Maximum Width	2.76 In (70.2 mm)
Maximum Height	3.43 In (87 mm)
Maximum Depth	2.43 In (61.6 mm)
Net Weight	0.42 Lb(US) (0.19 kg)

Environment

Directives	2006/95/EC - low voltage directive 86/188/EEC - physical agents (noise) directive
Standards	EN/IEC 60730
Product Certifications	EAC CSA CE CURus
Ambient air temperature for operation	-4...131 °F (-20...55 °C) UL 60730-1
Ambient Air Temperature for Storage	-40...185 °F (-40...85 °C)
Relative humidity	10...90 % non-condensing
IP degree of protection	IP20
Pollution degree	2

Ordering and shipping details

Category	22537 - M171 / M172 HVAC CONTROLLERS
Discount Schedule	PC12
GTIN	03606480752742
Nbr. of units in pkg.	1
Package weight(Lbs)	8.85 Oz (251 g)
Returnability	No
Country of origin	IT

Packing Units

Unit Type of Package 1	PCE
Package 1 Height	5.20 In (13.2 cm)
Package 1 width	3.54 In (9 cm)
Package 1 Length	7.28 In (18.5 cm)
Unit Type of Package 2	S02
Number of Units in Package 2	6
Package 2 Weight	4.10 Lb(US) (1.858 kg)
Package 2 Height	5.91 In (15 cm)
Package 2 width	11.81 In (30 cm)
Package 2 Length	15.75 In (40 cm)

Offer Sustainability

Sustainable offer status	Green Premium product
California proposition 65	WARNING: This product can expose you to chemicals including: Lead and lead compounds, which is known to the State of California to cause cancer and birth defects or other reproductive harm. For more information go to www.P65Warnings.ca.gov
REACH Regulation	REACH Declaration
REACH free of SVHC	Yes
EU RoHS Directive	Pro-active compliance (Product out of EU RoHS legal scope) EU RoHS Declaration
Mercury free	Yes
RoHS exemption information	Yes
China RoHS Regulation	China RoHS Declaration
Environmental Disclosure	Product Environmental Profile
Circularity Profile	End Of Life Information
WEEE	The product must be disposed on European Union markets following specific waste collection and never end up in rubbish bins.

Dimensions

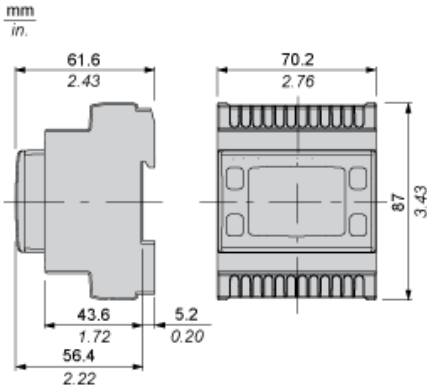

Mounting and Clearance

Clearance

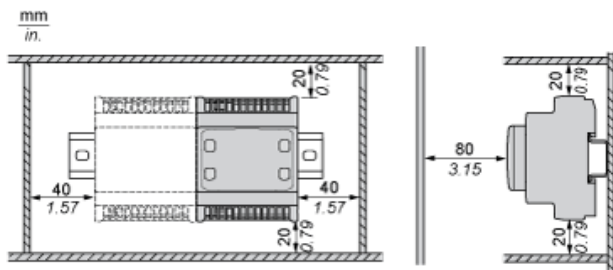

Misplacement

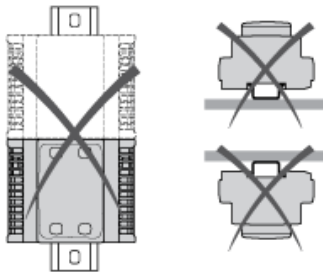

Power Supply

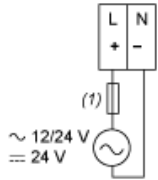

(1) Type T fuse (Controller: 1.25 A , Expansion: 1 A)

Wiring Diagram

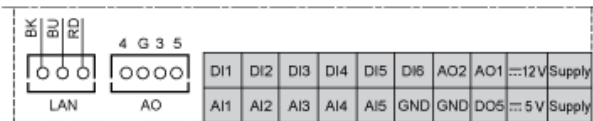
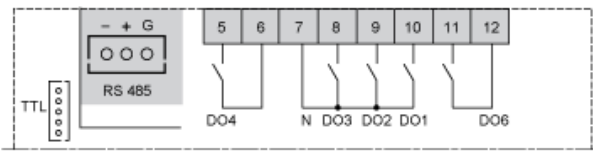
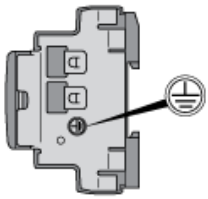

N : Neutral
GND Ground
BK : Black
BU : Blue
RD : Red
AI : Analogue input
AO : Analogue output
DI : Digital input
DO : Digital output

Product Life Status : **Commercialised**